

Push button, NO/NC Contact Block & Electrical Control Gear

**Features**

- Metal body for push button
- Engineering grade plastic for NO/NC contact
- Mounting size  $\Phi 22\text{mm}$
- Quick and Easy to Assemble
- Suitable for cascading of NO/NC block
- Available colour for push button: RED, GREEN, YELLOW, WHITE, BLACK, AND BLUE



**Technical data**

<b>Mechanical</b>	Fitment	Screw
	Mounting socket material	Al. Casting
	Plastic Material	Engineering Plastic
	Contact material	Bimetal (Cu/AG)
	Mounting Socket size	22.5mm
	Working temperature	-25 <sup>0</sup> C to 75 <sup>0</sup> C
	Flexible Wire	2 X 0.5 to 2.5 mm <sup>2</sup> (Max)
	Solid conductor Wire	2 X 0.5 to 2.5 mm <sup>2</sup> (Max)
	Degree of Protection	IP40
	Recommended Terminal screw Tightening Torque	1.25 Nm
	Mechanical Cycles	1 Million operations
<b>Electrical</b>	Contact Block Rated Voltage	AC380V DC 200 V
	Rated Insulation Voltage	Ui AC 500V
	Rated thermal current	10A
	Insulation resistance at 500 VDC	1.3 X 10 <sup>4</sup> Mega - Ohm
	Contact Block Switch rating	AC 15 : 415V, 4A DC 13: 110V, 0.5A
	Degree of Protection	IP40

**Product Dimension Drawing** (all dimensions in mm)

Standard conformity: IEC 60947- 5-1

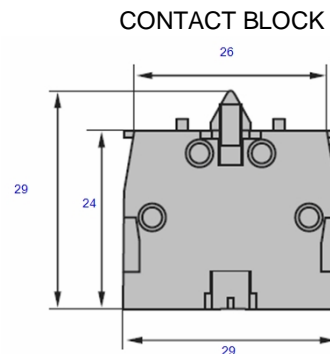
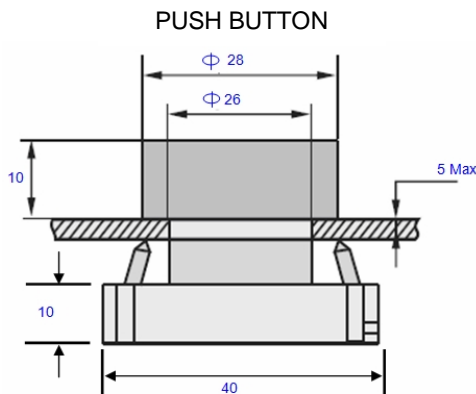

without prior notice

NO with Push button

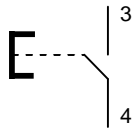

NC with Push button

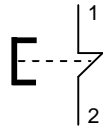

NO/NC with Push button

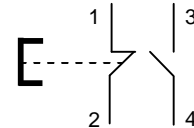

NC/NC

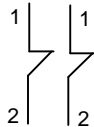

NO/NO

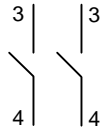

NO/NC

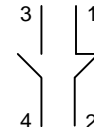

## Ordering Code Table

Sr. no	Description	Order code
1	NO contact	CR-NOC-GN
2	NC contact	CR-NCC-RD
3	Push button 22.5mm RED	CR-PB22-RD
4	Push button 22.5mm GREEN	CR-PB22-GN
5	Push button 22.5mm YELLOW	CR-PB22-YL
6	Push button 22.5mm BLUE	CR-PB22-BL
7	Push button 22.5mm BLACK	CR-PB22-BK
8	Selector switch 2 way	CR-SW22-2
9	Selector switch 3 way	CR-SW22-3
10	Selector switch spring return	CR-SW22-SR

Information in the datasheet is subject to modification without prior notice

Craftech, 354, II floor, Mulay I Square,  
Opp. Siemens, MIDC, Ambad,  
Nashik – 422010, INDIA

**craftech**  
Enhancing Business Performance  
Email: [info@craftech.co.in](mailto:info@craftech.co.in)  
[www.craftech.co.in](http://www.craftech.co.in)