

Push Button, NO/NC Contact Block & Electrical Control Gear

Technical Data Sheet

Version 0, Date: 29/9/23

Features

- Metal Body for Push Button
- Engineering Grade Plastic for NO/NC contact
- Mounting size $\Phi 22\text{mm}$
- Quick and Easy to Assemble
- Suitable for cascading of NO/NC block
- Available color for Push Button: RED, GREEN, YELLOW, WHITE, BLACK, BLUE



Technical data

Mechanical	Fitment	Screw
	Mounting socket material	Al. Casting
	Plastic Material	Engineering Plastic
	Contact Material	Bimetal (Cu/AG)
	Mounting Socket size	22.5mm
	Working temperature	-25°C to 75°C
	<i>Flexible Wire</i>	2 X 0.5 to 2.5 mm ² (Max)
	<i>Solid conductor Wire</i>	2 X 0.5 to 2.5 mm ² (Max)
	Degree of Protection	IP40
	Recommended Terminal Screw Tightening Torque	1.25 Nm
Mechanical Cycles	1 million operations	
Electrical	Contact Block Rated Voltage	AC380V DC 200 V
	Rated Insulation Voltage	Ui AC 500V
	Rated thermal current	10A
	Insulation resistance at 500 VDC	1.3 X 10 ⁴ Mega - Ohm
	Contact Block Switch rating	AC 15: 415V, 4A DC 13: 110V, 0.5A, 250 V, 0.25A
	Degree of Protection	IP 40

Product Dimension Drawing (all dimensions in mm, Tolerance +/-0.5mm)

Standard conformity: IEC 60947- 5-1

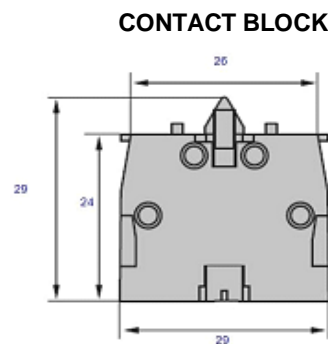
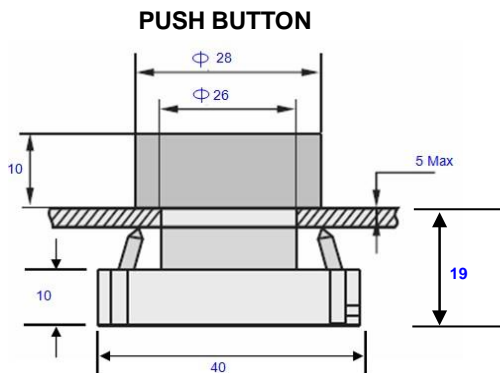

Information in the datasheet is subject to modification without prior notice

Craftech, 264, I floor, Mulay I Square,
Opp. Siemens, MIDC, Ambad,
Nashik – 422010, INDIA

Email: info@craftech.co.in
www.craftech.co.in



Push Button, NO/NC Contact Block & Electrical Control Gear

NO with Push button

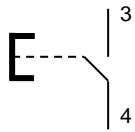

NC with Push button

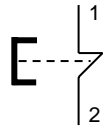

NO/NC with Push button

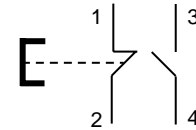

NC/NC

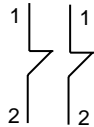

NO/NO

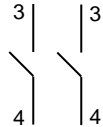

NO/NC

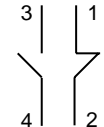

Ordering Code Table

Sr. no	Description	Order code
1	NO contact	CR-NOC-GN
2	NC contact	CR-NCC-RD
3	Push Button 22.5mm RED	CR-PB22-RD
4	Push Button 22.5mm GREEN	CR-PB22-GN
5	Push Button 22.5mm YELLOW	CR-PB22-YL
6	Push Button 22.5mm BLUE	CR-PB22-BL
7	Push Button 22.5mm BLACK	CR-PB22-BK
8	Selector Switch 2 way	CR-SW22-2
9	Selector Switch 3 way	CR-SW22-3
10	Selector Switch Spring return	CR-SW22-SR
11.	Mushroom Head Emergency Push Button Stay put (Turn to release)	CR-EM22-SP
12.	Mushroom Head Emergency Push Button Momentary (Spring return)	CR-EM22-SR

Information in the datasheet is subject to modification without prior notice

Craftech, 264, I floor, Mulay I Square,
Opp. Siemens, MIDC, Ambad,
Nashik – 422010, INDIA

Email: info@craftech.co.in
www.craftech.co.in